



Profiles and installation systems for bathrooms

PP DRAIN AQUA

Description

PP Drain Aqua is a range of linear drains for floor-level showers, suitable for ceramic tiles, natural stone and other coverings.

PP Drain Aqua linear shower drains are made of stainless steel AISI 316 – DIN 1.4404 and are available in a wide selection of covers, with and without frame.

All covers can be adapted to coverings with thickness from 6 to 18 mm (except Invisible Cover which is suitable for coverings of any thickness).

PP Drain Aqua are available with horizontal-drain siphon DN40 (drainage capacity 50 litres/minute), direct vertical drain DN50 or 360° swivel-drain siphon DN40 (drainage capacity 30 litres/minute).

The linear shower drains with siphon have a floor-level height of 70 mm, the 360° swivel-drain siphon have a floor-level height of 65 mm, and for both visible covers have a length from 60 to 120 cm.

The shower drain body is equipped with a solidly glued waterproofing membrane (compliant with DIN 18534): this guarantees a perfect integration of the linear shower drain itself with the waterproofing system of the shower area.

The covers and the frame (when present) have special adjustment supports from 6 to 18 mm, also available in the tileable vanishing version Invisible Cover for coverings of any thickness.

Range

PP Drain Aqua (shower drain base with siphon)

Linear shower drain with siphon diam. 40 mm, waterproofing membrane, support bases, hair catcher filter in stainless steel.

Available in lengths 60, 70, 80, 90, 100, 120 cm.

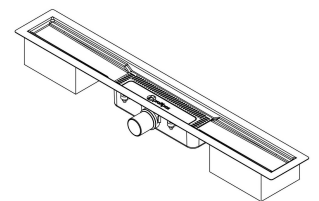

PP Drain Aqua (shower drain base with direct drainage diam. 50 mm)

Linear shower drain with vertical tube diam. 50 mm, waterproofing membrane, support bases.

Siphon and hair catcher filter are not present.

Available in lengths 60, 70, 80, 90, 100, 120 cm.

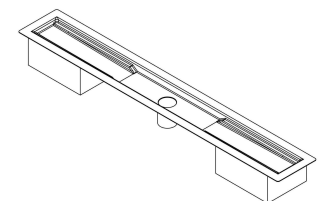

PP Drain AQUA (gutter base with 360° swivelling siphon)

Drain complete with 360° swivelling PP siphon with 40 mm diameter outlet complete with hair trap filter, waterproof membrane, adjustable support feet.

Available in lengths 60, 70, 80, 90, 100, 120 cm.

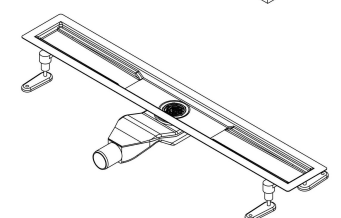

Classic Cover XPC

Cover with frame and adjustment supports for tiles from 6 to 18 mm.

Available in polished and satin stainless steel AISI 316 – DIN 1.4404 and in lengths 60, 70, 80, 90, 100, 120 cm.

Classic Cover is reversible: if turned upside down, it can be filled with the tile (maximum thickness 12 mm).

Keep a gap between the frame and the tile (2 mm recommended on the 4 sides) and fill it with an appropriate sealant.

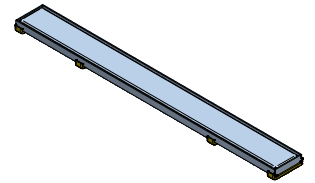

Overturned Classic Cover

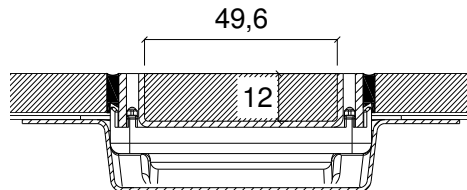
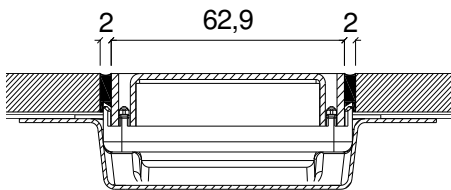

Invisible Cover XPI

Cover in extruded natural aluminium.

Available in lengths 60, 70, 80, 90, 100, 120 cm.

The kit includes spacers to be used during the installation to create the necessary gap between the tiles and the cover for the water outflow (3 or 4 mm recommended on the long sides).

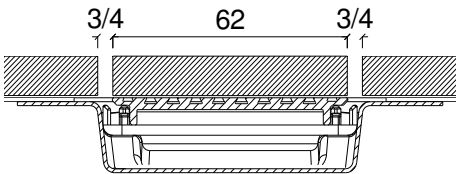
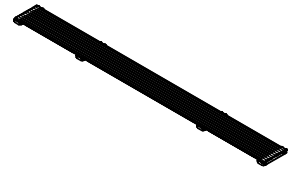

Flat Cover (aluminium + stainless steel) XPF

Cover in natural aluminium + stainless steel AISI 316 – DIN 1.4404 with adjustment supports for tile thickness from 6 to 18 mm. Available in different finishes and colours, in lengths 60, 70, 80, 90, 100, 120 cm.

The kit includes spacers to be used during the installation to create the necessary gap between the tiles and the cover for the water outflow (3 or 4 mm recommended on the long sides).

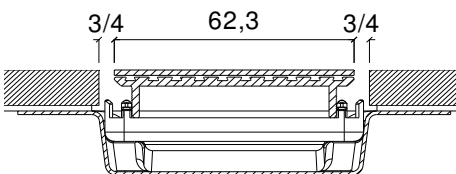
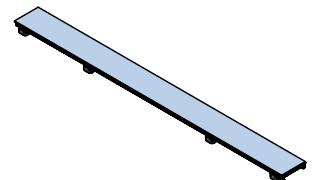

Flat Cover (aluminium) XPF

Cover in soft touch colour-coated aluminium with adjustment supports for tile thickness from 6 to 18 mm.

Available in different colours, in lengths 60, 70, 80, 90, 100 cm.

The kit includes spacers to be used during the installation to create the necessary gap between the tiles and the cover for the water outflow (3 or 4 mm recommended on the long sides).

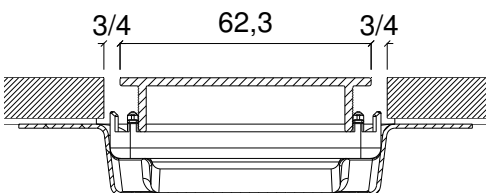
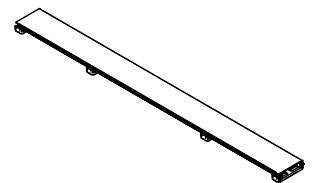

Design Cover XPD

Stainless steel AISI 316 – DIN 1.4404 cover with adjustment supports for tile thickness from 6 to 18 mm.
 Available in different finishes, in lengths 60, 70, 80, 90, 100, 120 cm.
 During the installation, pull the tiles and Design Cover together.

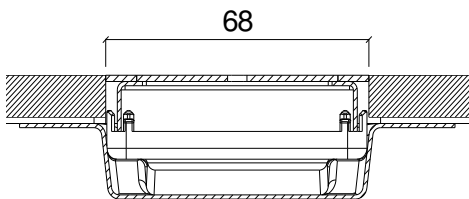
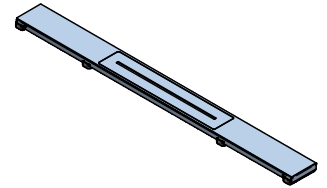

Materials

Shower drain body in stainless steel AISI 316 – DIN 1.4404 made by moulding.
 Frame, cover and hair catcher filter in stainless steel AISI 316 – DIN 1.4404.
 The waterproofing membrane in soft polyethylene has a special polypropylene textile on both sides to guarantee an effective fastening with the adhesive.
 Drain, siphon and supports in antibacterial ABS, siphon top in transparent antibacterial MABS.
 Bases in extruded polystyrene.

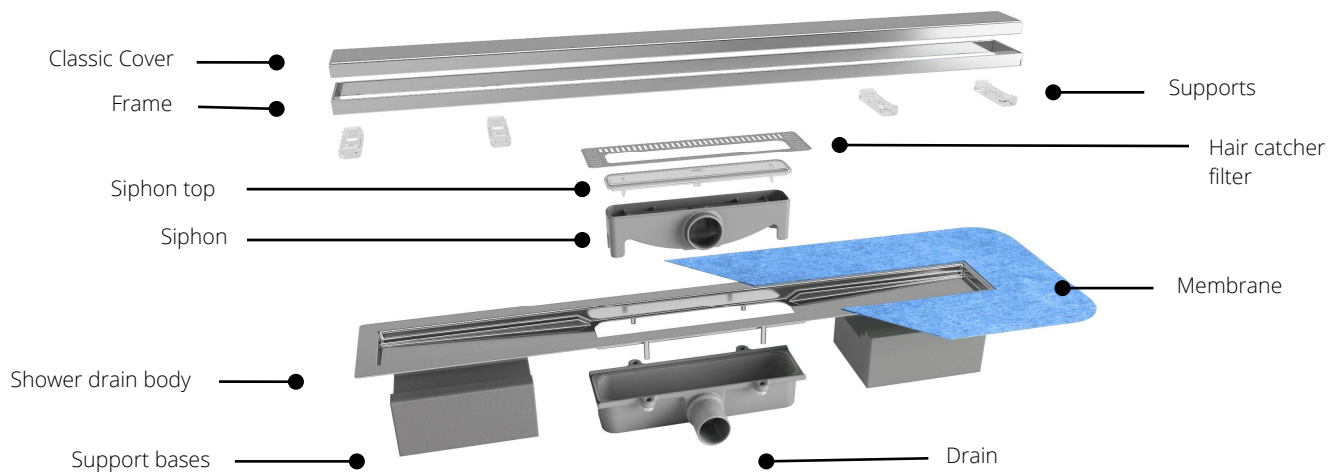

Shower drain base with direct drainage
 50 mm diameter



Shower drain base with 360° swivel-drain
 siphon 40 mm diameter

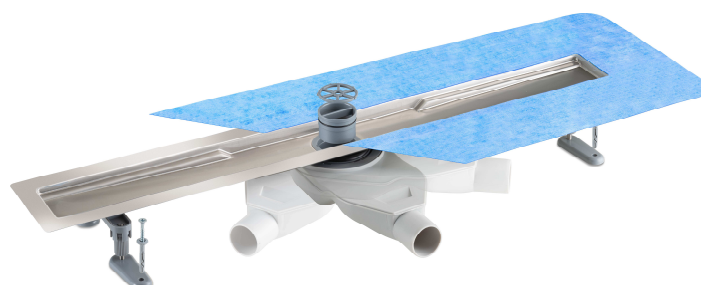

Stainless Steel AISI 316 - DIN 1.4404

Especially resistant to the main chemical and atmospheric agents, to lime, mortar, tile adhesives and cleaning products.
 Also recommended for use in food industries, hospitals, external environments in general, etc.

Waterproofing membrane

Material composition	: polyethylene waterproofing membrane, 0.2 mm thickness, inserted between two polypropylene layers for a total thickness of approx. 0.5 mm
Weight	: approx.. 277 g/mq
Temperature resistance	: -30°C / +90°C
Colour	: green
Longitudinal breaking load	: 300N / 50 mm
Lateral breaking load	: 145N / 50 mm
Longitudinal breaking elongation	: 65%
Lateral breaking elongation	: 65%
Resistance to longitudinal laceration	: 60N / 50 mm
Resistance to lateral laceration	: 115N / 50 mm
Resistance to water pressure	: ≥ 1,5 bar
Substrate adhesion	: ≥ 0,4 N/mm ²
UV resistance	: ≥ 450 h
Vapour permeability (sd)	
According to ETAG 022 methodology	: ≥ 50 m
Fire-resistance rating	: B2

Antibacterial ABS- Antibacterial MABS

Antibacterial compound of Acrylonitrile Butadiene Styrene (ABS), flammability rating HB (according to UL94 test).

General notes on metals

Stainless steel is not resistant to every chemical compound. Consequently, contact with particularly aggressive products like hydrochloric acid (HCl) and phosphoric acid (H3P04) should be avoided.

Products generally used to clean stone, ceramic and porcelain stoneware tiles, such as muriatic acid, ammonia and bleach, damage the surface finish of the metal and can cause intense corrosion. Moreover, any residues of concrete, adhesive, and grouting materials must always be removed from the surface of the products as quickly and delicately as possible.

If adhesive tape is used to cover the product, it must not be left any longer than an hour.

Installation

1. Before starting the installation, check that the contents of the package is complete and intact.
2. Define the height of the finished floor, considering the slopes for water drainage.
3. Apply adhesive or mortar to the substrate and position the support bases and the shower drain body in the desired point.
4. Level the shower drain with a spirit level and adjust the height.
5. Connect the drain to the drainage network through a plug-in tube of proper diameter. Once the tube has been inserted, test its functionality with a leak test.
6. Stop the shower drain with fast-setting concrete or adhesive, considering that the perimetral flange must have a height that, once the floor has been laid, contains the thickness of the tiles and the adhesive. In any case, the installation has to be made considering the tile thickness.
7. Proceed to the realization of the sloping screed, by leveling it flush with the upper edge of the flange and paying attention not to cut the pre-glued waterproofing membrane.
8. The support must be flat and free of residues that could compromise the adhesion of the membrane.
9. In case of thin-layer waterproofing (liquid membrane), after the laying of the corners and the sealing tapes between floor and wall and wall and wall (inside and outside corners), proceed to the directions of the manufacturer.
10. In case of waterproofing with WPstop, proceed to the directions provided in the specific technical sheet, by respecting the gripping time of the adhesive.

CLASSIC COVER

11. Position the frame by choosing the supports height according to the thickness of the covering and the adhesive.
12. Fasten two supports (among those not used) to the upper part of the frame, then insert the frame on the supports inside the linear shower drain making sure it is well fastened.
13. After waterproofing, proceed to glue the covering, by keeping it at a distance of about 2 mm from the perimeter of the frame.
14. Remove the two supports previously inserted above the frame and seal the gap between the tile and the frame with a suitable product.
15. Insert the chosen cover inside the frame of the linear shower drain.

INVISIBLE COVER

16. Proceed to cut and glue the covering inside Invisible Cover.
17. Position Invisible Cover with the glued tile inside the shower drain by using the supplied supports.
18. After waterproofing, proceed to glue the covering, by keeping it at a distance of about 3 or 4 mm from the tile of the cover on the long sides (use the specific supplied spacers inside the cover package) to allow a correct flow of water inside the linear shower drain.

FLAT COVER

19. Position Flat Cover by choosing the supports height according to the thickness of the covering and the adhesive.
20. After waterproofing, proceed to glue the covering, by keeping it at a distance of about 3 or 4 mm from Flat Cover on the long sides (use the specific supplied spacers inside the cover package) to allow a correct flow of water inside the linear shower drain.

DESIGN COVER

21. Position Design Cover by choosing the supports height according to the thickness of the covering and the adhesive.
22. After waterproofing, proceed to glue the covering by pulling the tiles and Design Cover together.

Care and maintenance

The care and maintenance of the materials used for the realisation of these products are closely linked to the type of alloy and/or used finishing.

The intent of this is to provide all those general guidelines that can serve as guidelines in the choice of when and how to clean, but they will have to be checked case by case.

It must be underlined that there are precise and specific responsibilities at every stage of product life since its installation.

Stainless Steel

The stainless steel surfaces can be polished with the adequate products, commonly found in stores.

Stainless steel is easy to clean and extremely hygienic; its smooth and non-porous surface makes it especially difficult for the adhesion and survival of bacteria and/or other micro-organisms.

Some simple guidelines are all that is required to keep steel surfaces perfect: it is sufficient to wash with hot water and soap, rinsing abundantly and drying with a soft cloth.

If the surface is exposed to atmospheric or aggressive agents, periodic cleaning of the product is recommended in order to keep the surface unaltered and prevent the onset of corrosion.

On brushed finish surfaces, always clean in the direction of the grain and never across it.

For scratches, use a detergent/polish suitable for stainless steel and a soft cloth.

Under no circumstances should the following be used for cleaning:

- detergents containing hydrochloric acid (muriatic acid), hydrofluoric acid or bleach; avoid direct contact on the surface of detergents containing chlorine, unless the contact time is brief and followed up by an immediate rinsing with abundant amount of water;
- detergents in abrasive powder form that could damage the surface finish of the product.

Avoid allowing objects and tools in common steel (e.g. brushes or steel wool normally used to remove residual mortar or similar products) to come into contact with products in stainless steel for a prolonged period, otherwise they could transfer ferrous particles (contamination), causing the appearance of rust stains on the surface.

Prevent humid pieces of material or sponges to lay for a prolonged period of time in contact with the stainless steel surface in order to prevent unsightly water stains.

Siphon cleaning (where present)

Procedure for disassembling and cleaning the siphon:

- Lift the cover
- Lift the stainless steel hair catcher filter and proceed to clean
- Unfasten the siphon from the drain by pulling it out from the tube
- Clean the siphon with water and neutral detergents. If there are residues that are difficult to remove inside the siphon, proceed to remove the transparent top using the special fixing hooks
- After cleaning, reassemble everything, making sure that the siphon is well inserted in the drain inlet

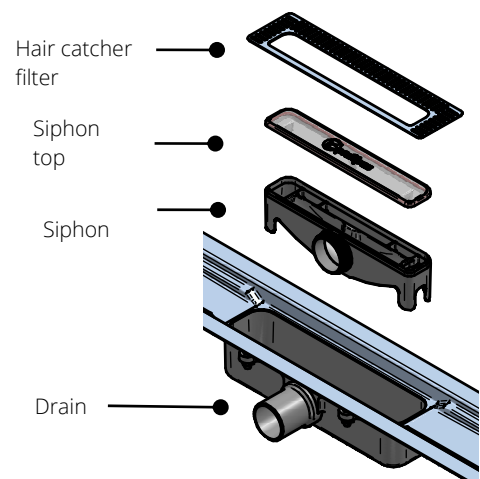

Fire control measures

In case of fire, extinguish with fire-fighting chemical products, dry sand or solid fire-extinguishing agents.

Notes

These products must be handled with care, taking the necessary steps to use suitable gloves to prevent wounds such as cuts to the hand. All indications and instructions here have come from our own experience to be understood as purely informative and will have to be confirmed through exhaustive practical experience. Profilpas will not be held responsible for any personal injury or material damage from improper use of the product. The user is responsible for establishing whether the product is suitable for the task and likewise must assume all responsibility for incorrect laying of material.

PP Drain Aqua

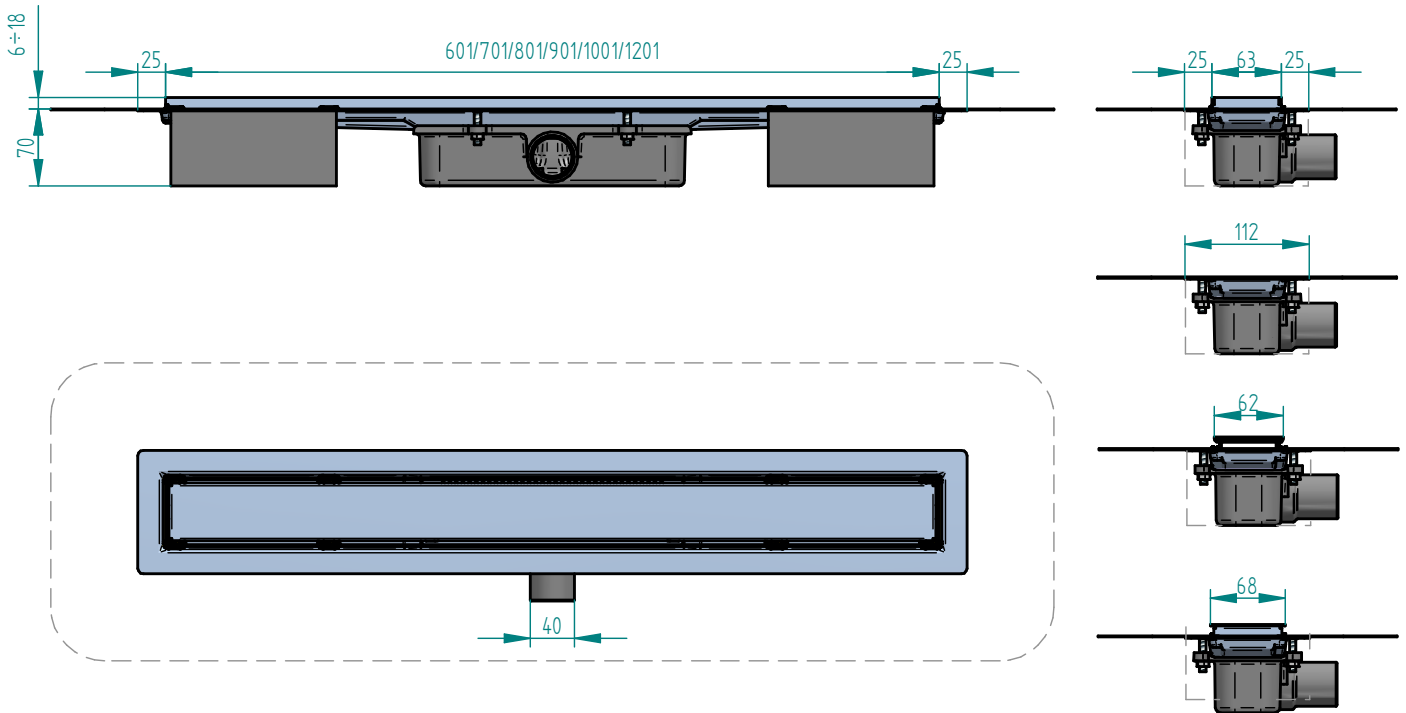

Plan view with Classic Cover

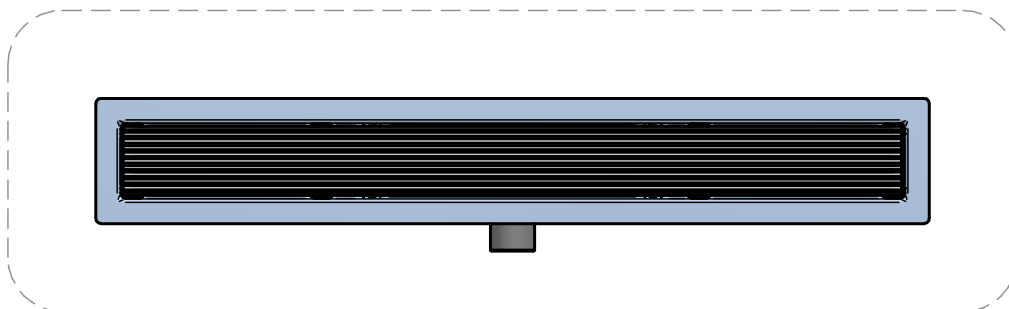

Plan view with Invisible Cover

PP Drain Aqua

With PP Drain Aqua linear shower drains, maintenance and cleaning are fully simplified. The siphon, made of antibacterial ABS, can be removed and inspected completely. Furthermore, the AISI 316 stainless steel shower drain base is composed of a single piece without welds and sharp edges for the best hygiene and efficiency. Studied to minimize installation times, they are equipped with a pre-glued waterproofing membrane, supports from 6 to 18 mm for the height adjustment of the covers and bases in polystyrene foam.

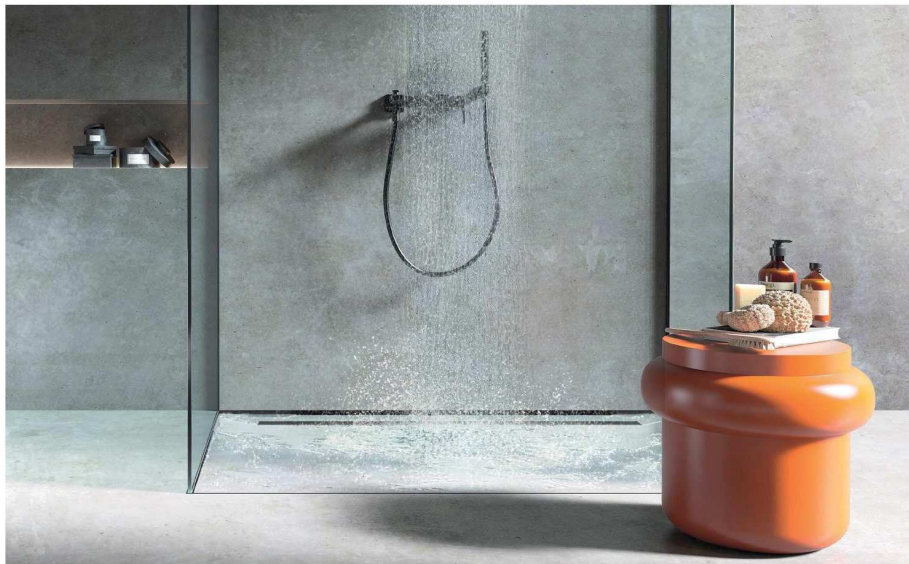

PP Drain Aqua



pp drain aqua PP



pp drain aqua PP50

PP DRAIN AQUA - shower drain base with siphon

ART.	finishing		60 cm	70 cm	80 cm	90 cm	100 cm	120 cm
STAINLESS STEEL								
PP/	stainless steel AISI 316 DIN 1.4404		22100	22101	22102	22103	22104	22105

PP DRAIN AQUA - shower drain base with direct drainage diam. 50 mm

ART.	finishing		60 cm	70 cm	80 cm	90 cm	100 cm	120 cm
STAINLESS STEEL								
PP50/	stainless steel AISI 316 DIN 1.4404		22106	22107	22108	22109	22110	22111

Shower drain base with direct drainage diam. 40 mm available upon request.

cover¹

frame²

ABS supports

hair catcher filter

removable top in antibacterial ABS

removable siphon in antibacterial ABS

waterproofing membrane

single-piece base in stainless steel AISI 316

base in polystyrene

drain in antibacterial ABS

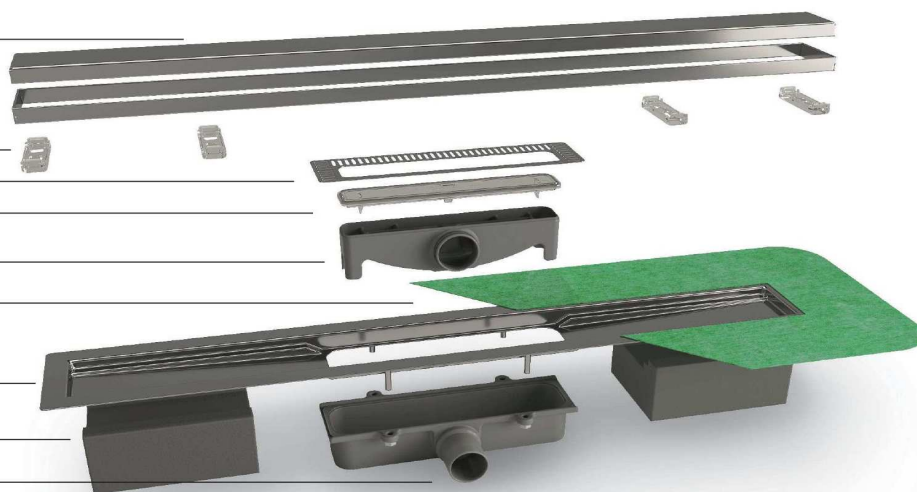

¹ Different types of cover available.

² The frame is present in Classic Cover model. The other covers are not equipped with frame.

Complete the article code with L measure (for example PP/ for L = 70 becomes PP/70)

PP Drain Aqua

Classic Cover, in polished or satin stainless steel AISI 316, is available in different lengths (from 60 to 120 cm). It includes the frame and the adjustment supports from 6 to 18 mm, and it is reversible: if turned upside down, it becomes tileable (up to 12 mm), thus creating aesthetic continuity with the bathroom covering.

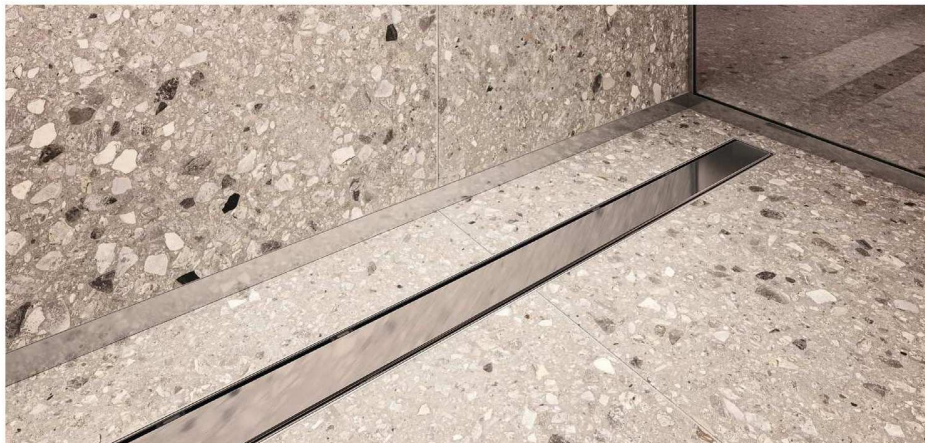

PP Drain Aqua - Classic Cover polished stainless steel AISI 316 - DIN 1.4404

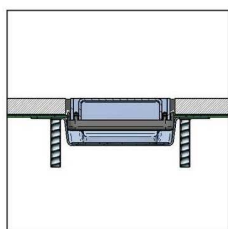

Classic Cover

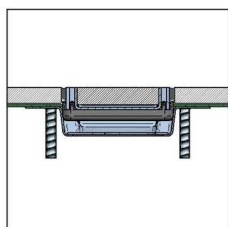



Classic Cover
tileable



Classic Cover satin stainless steel
AISI 316 DIN 1.4404

Complete the article code with L measure
(for example XPC/ for L = 70 becomes XPC/70)

CLASSIC COVER - tiles thickness from 6 to 18 mm

ART.	finishing	L						
		60 cm	70 cm	80 cm	90 cm	100 cm	120 cm	
STAINLESS STEEL								
	polished stainless steel AISI 316 DIN 1.4404		22112	22113	22114	22115	22116	22117
XPC/	satin stainless steel AISI 316 DIN 1.4404		22118	22119	22120	22121	22122	22123

Classic Cover is reversible, if turned upside down it becomes tileable (with a thickness up to 12 mm).



PP Drain Aqua - Classic Cover satin stainless steel AISI 316 - DIN 1.4404

PP Drain Aqua

Flat Cover, available in several finishes and different lengths (from 60 to 120 cm), stands out for the perfectly flat and linear design. It is provided with adjustment supports that allow it to be adapted to tiles with thickness from 6 to 18 mm.



PP Drain Aqua - Flat Cover matt black colour-coated aluminium

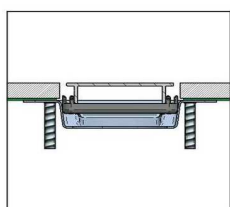

Flat Cover
aluminium

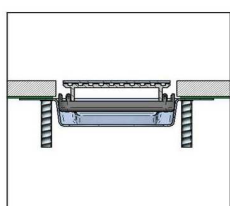











Flat Cover
aluminium +
stainless steel



Flat Cover chromium-plated stainless steel

FLAT COVER - tiles thickness from 6 to 18 mm

ART.	finishing	L						
		60 cm	70 cm	80 cm	90 cm	100 cm	120 cm	
ALUMINIUM + STAINLESS STEEL								
XPF/	polished stainless steel AISI 316 DIN 1.4404		22136	22137	22138	22139	22140	22141
	satin stainless steel AISI 316 DIN 1.4404		22142	22143	22144	22145	22146	22147
ALUMINIUM + CHROMIUM-PLATED STAINLESS STEEL								
XPF/	chromium-plated stainless steel AISI 316 DIN 1.4404		22261	22262	22263	22264	22265	-
COLOUR-COATED ALUMINIUM								
XPF/	matt white		22148	22149	22150	22151	22152	-
	matt black		22154	22155	22156	22157	22158	-
ALUMINIUM + STAINLESS STEEL								
XPF/	polished nickel		22226	22227	22228	22229	22230	-
	satin nickel		22231	22232	22233	22234	22235	-
	polished pink gold		22236	22237	22238	22239	22240	-
	polished graphite		22241	22242	22243	22244	22245	-
	satin graphite		22246	22247	22248	22249	22250	-
	polished gold		22251	22252	22253	22254	22255	-
	satin gold		22256	22257	22258	22259	22260	-



Flat Cover

Complete the article code with L measure
(for example XPF/ for L = 70 becomes XPF/70)

PP Drain Aqua

Design Cover stands out for the absolute elegance of its design and for the central drain. In polished or satin stainless steel AISI 316, it is available in different lengths, from 60 to 120 cm.

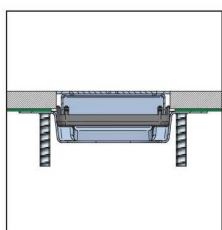

Design Cover





Design Cover



PP Drain Aqua - Design Cover satin stainless steel AISI 316 DIN 1.4404

DESIGN COVER - tiles thickness from 6 to 18 mm

ART.	finishing	L						
		60 cm	70 cm	80 cm	90 cm	100 cm	120 cm	
STAINLESS STEEL								
XPD/	polished stainless steel AISI 316 DIN 1.4404		22214	22215	22216	22217	22218	22219
	satin stainless steel AISI 316 DIN 1.4404		22220	22221	22222	22223	22224	22225

With Invisible Cover, the shower tray and the linear shower drain become as one and blend perfectly with the bathroom covering. In natural aluminium and different lengths (from 60 to 120 cm), it disappears under the tile for a completely invisible aesthetic effect.

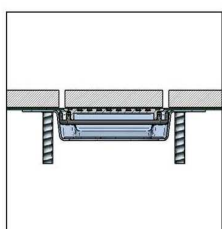

Invisible Cover



Invisible Cover

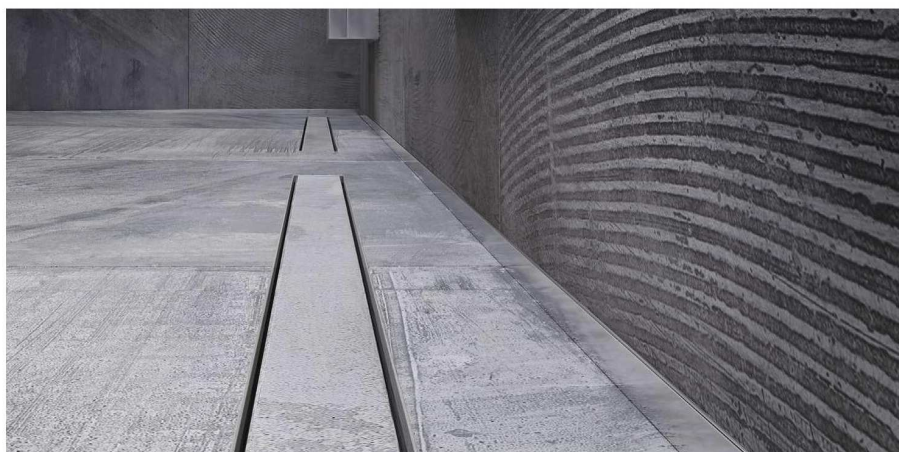

PP Drain Aqua - Invisible Cover

INVISIBLE COVER

ART.	finishing	L						
		60 cm	70 cm	80 cm	90 cm	100 cm	120 cm	
ALUMINIUM								
XPI/	natural aluminium		22130	22131	22132	22133	22134	22135

PP Drain Aqua

PP DRAIN AQUA 360 - shower drain base with siphon 360° adjustable

ART.	finitura	60 cm	70 cm	80 cm	90 cm	100 cm	120 cm
STAINLESS STEEL							
PP360/	stainless steel AISI 316 DIN 1.4404	 22180	22181	22182	22183	22184	22185

